

80V N-Ch Power MOSFET

Feature

- ◇ High Speed Power Switching, Logic Level
- ◇ Enhanced Body diode dv/dt capability
- ◇ Enhanced Avalanche Ruggedness
- ◇ 100% UIS Tested, 100% Rg Tested
- ◇ Lead Free, Halogen Free

V_{DS}		80	V
$R_{DS(on),typ}$	$V_{GS}=10V$	9.5	mΩ
$R_{DS(on),typ}$	$V_{GS}=4.5V$	13.5	mΩ
I_D (Silicon Limited)		12	A

Application

- ◇ Synchronous Rectification in SMPS
- ◇ Hard Switching and High Speed Circuit
- ◇ DC/DC in Telecoms and Industrial

SOIC-8

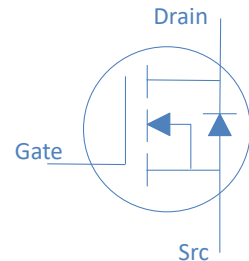
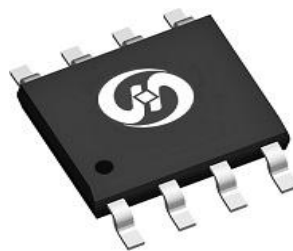

Part Number	Package	Marking
HGS110N08AL	SOIC-8	GS110N08AL

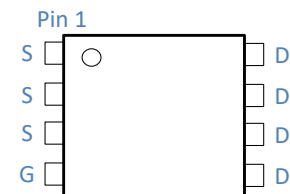

Absolute Maximum Ratings at $T_i=25^{\circ}C$ (unless otherwise specified)

Parameter	Symbol	Conditions	Value	Unit
Continuous Drain Current (Silicon Limited)	I_D	$T_C=25^{\circ}C$	12	A
		$T_C=100^{\circ}C$	8	
Drain to Source Voltage	V_{DS}	-	80	V
Gate to Source Voltage	V_{GS}	-	± 20	V
Pulsed Drain Current	I_{DM}	-	56	A
Avalanche Energy, Single Pulse	E_{AS}	$L=0.4mH, T_C=25^{\circ}C$	45	mJ
Power Dissipation	P_D	$T_C=25^{\circ}C$	3.1	W
Operating and Storage Temperature	T_J, T_{stg}	-	-55 to 150	$^{\circ}C$

Absolute Maximum Ratings

Parameter	Symbol	Max	Unit
Thermal Resistance Junction-Lead	$R_{\theta JL}$	25	$^{\circ}C/W$
Thermal Resistance Junction-Ambient ($t \leq 10s$)	$R_{\theta JA}$	40	$^{\circ}C/W$
Thermal Resistance Junction-Ambient (steady state)		75	$^{\circ}C/W$

Electrical Characteristics at $T_J=25^\circ\text{C}$ (unless otherwise specified)
Static Characteristics

Parameter	Symbol	Conditions	Value			Unit
			min	typ	max	
Drain to Source Breakdown Voltage	$V_{(BR)DSS}$	$V_{GS}=0V, I_D=250\mu A$	80	-	-	V
Gate Threshold Voltage	$V_{GS(th)}$	$V_{GS}=V_{DS}, I_D=250\mu A$	1.0	1.9	2.4	V
Zero Gate Voltage Drain Current	I_{DSS}	$V_{GS}=0V, V_{DS}=80V, T_J=25^\circ\text{C}$	-	-	1	μA
		$V_{GS}=0V, V_{DS}=80V, T_J=100^\circ\text{C}$	-	-	100	
Gate to Source Leakage Current	I_{GSS}	$V_{GS}=\pm 20V, V_{DS}=0V$	-	-	± 100	nA
Drain to Source on Resistance	$R_{DS(on)}$	$V_{GS}=10V, I_D=10A$	-	9.5	11.5	$m\Omega$
	$R_{DS(on)}$	$V_{GS}=4.5V, I_D=5A$	-	13.5	16	$m\Omega$
Transconductance	g_{fs}	$V_{DS}=5V, I_D=10A$	-	40	-	S
Gate Resistance	R_G	$V_{GS}=0V, V_{DS}$ Open, $f=1\text{MHz}$	-	1.3	-	Ω

Dynamic Characteristics

Input Capacitance	C_{iss}	$V_{GS}=0V, V_{DS}=40V, f=1\text{MHz}$	-	1131	-	pF
Output Capacitance	C_{oss}		-	205	-	
Reverse Transfer Capacitance	C_{rss}		-	8.5	-	
Total Gate Charge	$Q_g(10V)$	$V_{DD}=40V, I_D=10A, V_{GS}=10V$	-	23	-	nC
Total Gate Charge	$Q_g(4.5V)$		-	12.5	-	
Gate to Source Charge	Q_{gs}		-	3	-	
Gate to Drain (Miller) Charge	Q_{gd}		-	6	-	
Turn on Delay Time	$t_{d(on)}$	$V_{DD}=40V, I_D=10A, V_{GS}=10V, R_G=10\Omega,$	-	8	-	ns
Rise time	t_r		-	3	-	
Turn off Delay Time	$t_{d(off)}$		-	22	-	
Fall Time	t_f		-	4	-	

Reverse Diode Characteristics

Diode Forward Voltage	V_{SD}	$V_{GS}=0V, I_F=20A$	-	0.9	1.2	V
Reverse Recovery Time	t_{rr}	$V_R=40V, I_F=10A, di_F/dt=100A/\mu s$	-	35	-	ns
Reverse Recovery Charge	Q_{rr}		-	30	-	nC

Fig 1. Typical Output Characteristics

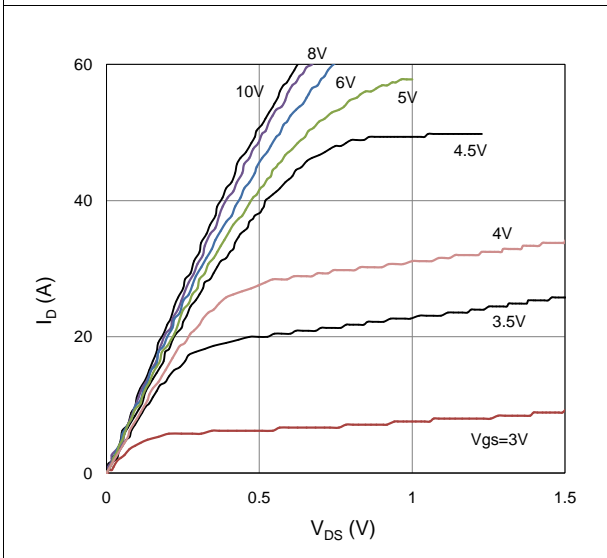

Figure 2. On-Resistance vs. Gate-Source Voltage

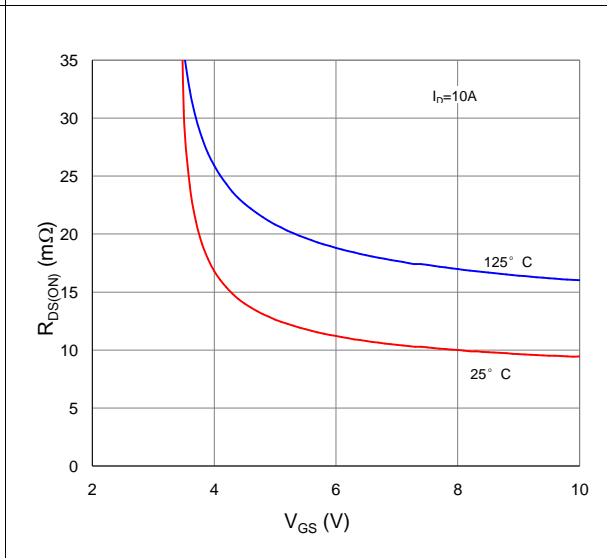

Figure 3. On-Resistance vs. Drain Current and Gate Voltage

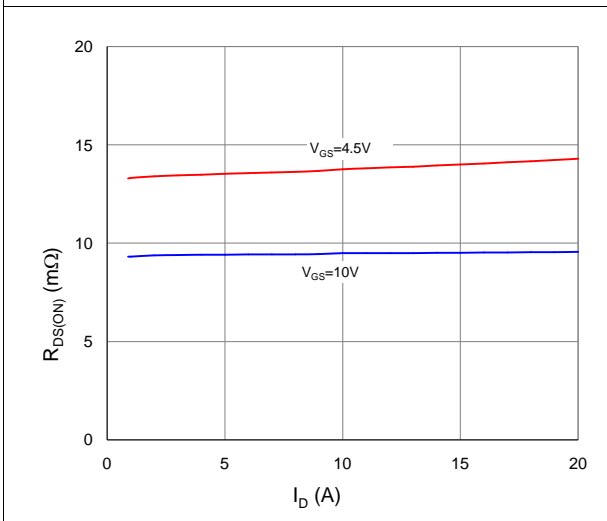

Figure 4. Normalized On-Resistance vs. Junction Temperature

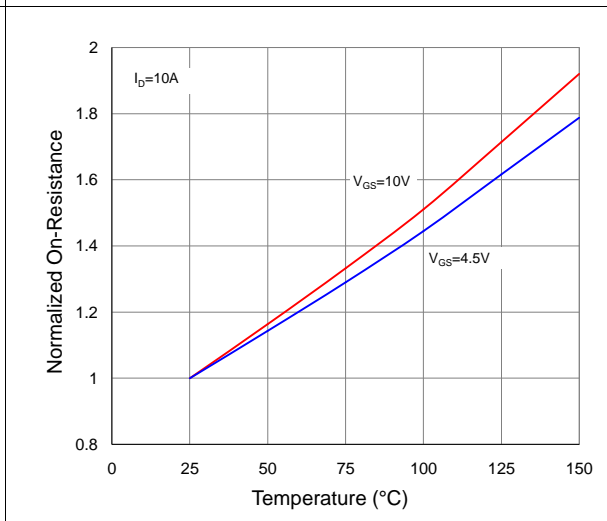

Figure 5. Typical Transfer Characteristics

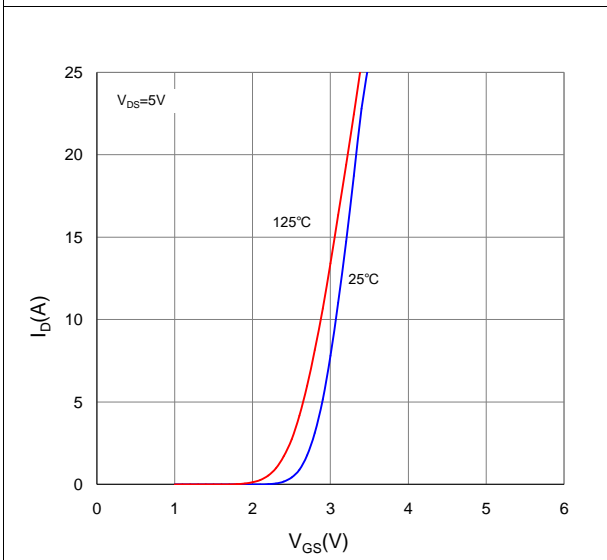

Figure 6. Typical Source-Drain Diode Forward Voltage

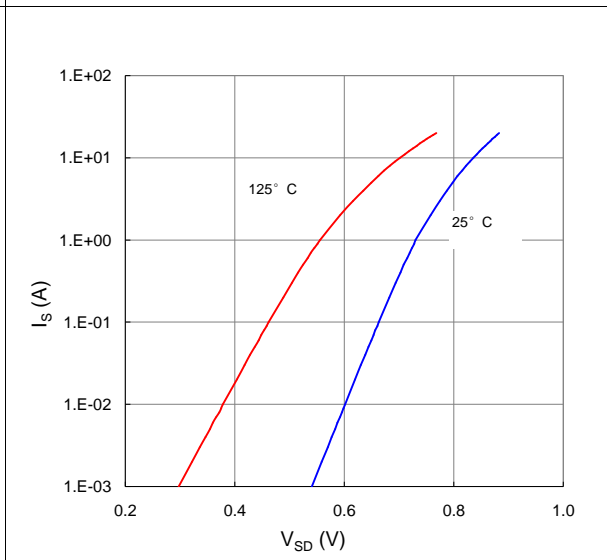

Figure 7. Typical Gate-Charge vs. Gate-to-Source Voltage

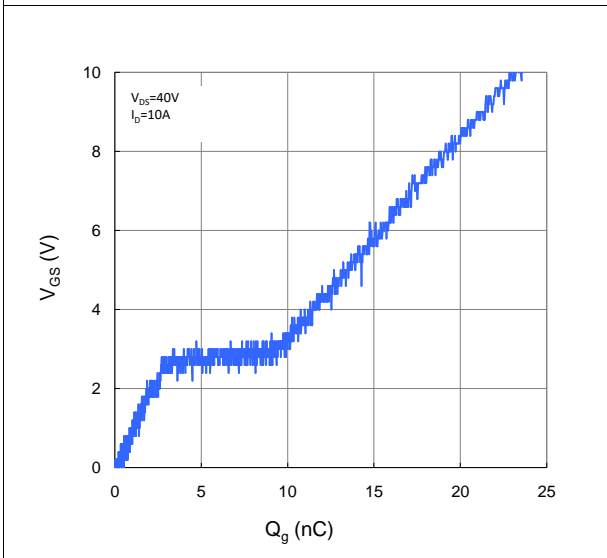

Figure 8. Typical Capacitance vs. Drain-to-Source Voltage

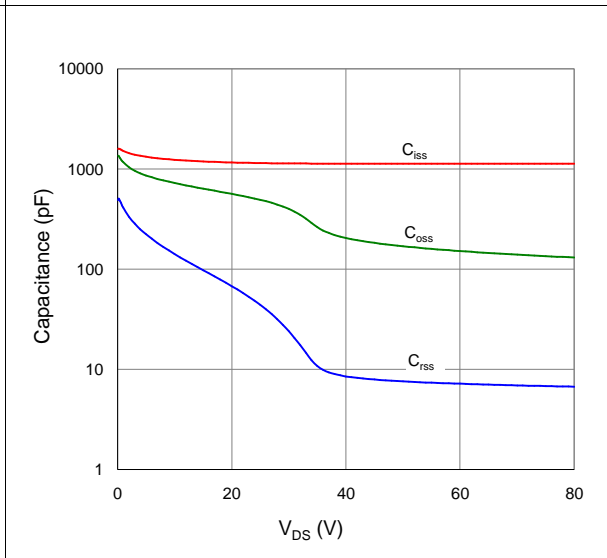

Figure 9. Maximum Safe Operating Area

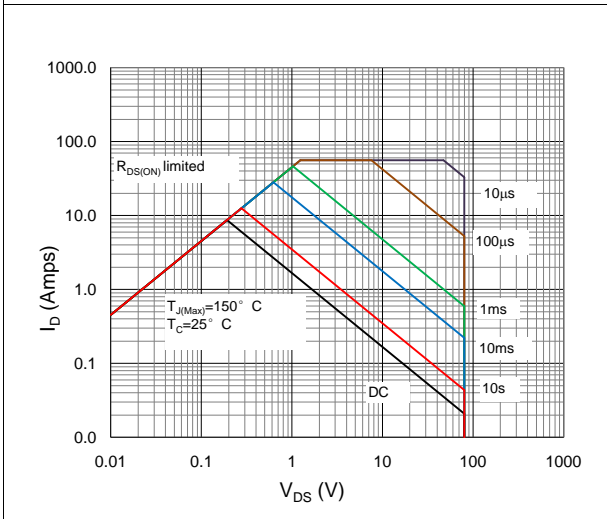

Figure 10. Maximum Drain Current vs. Case Temperature

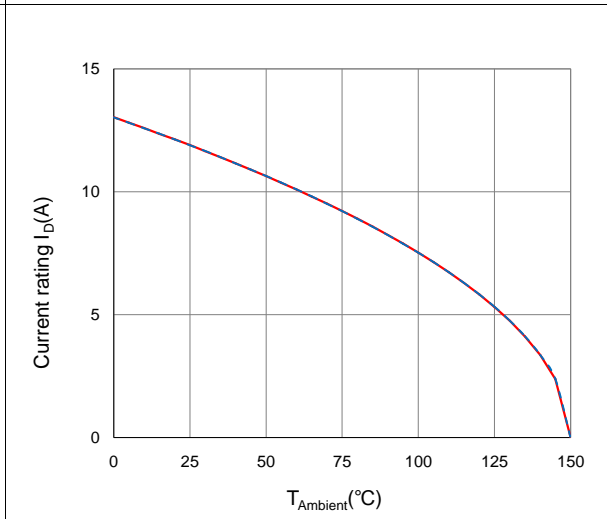
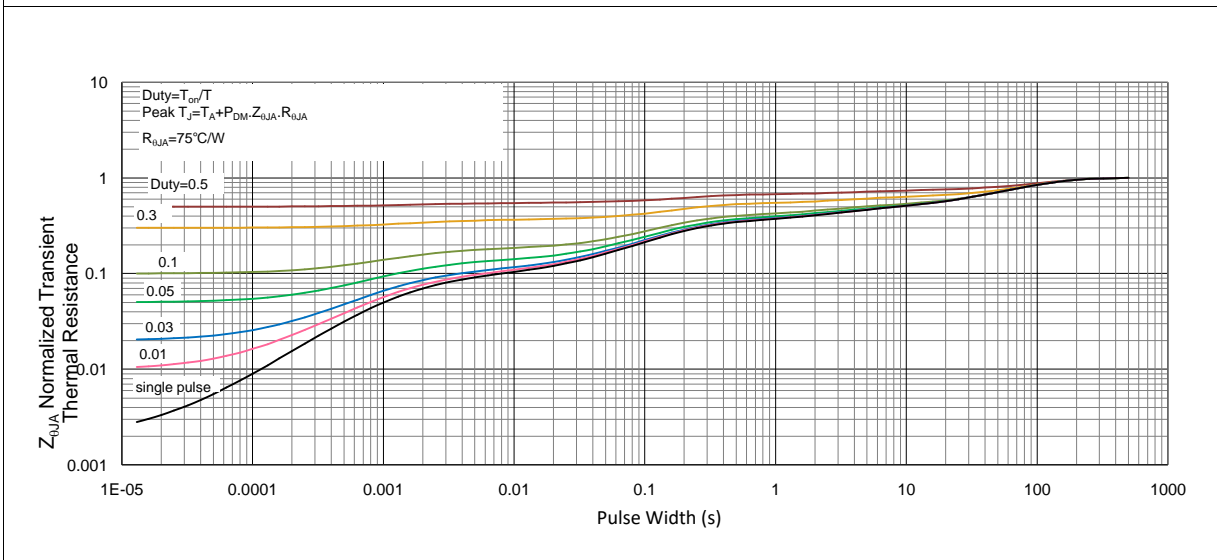
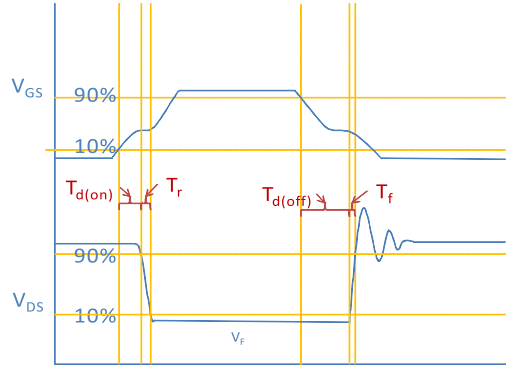
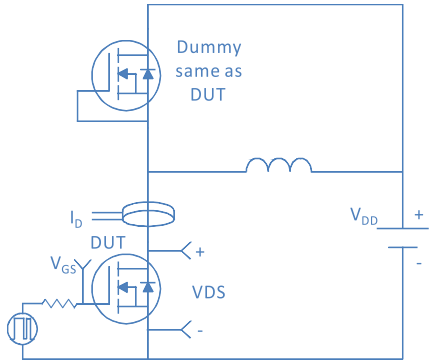

Figure 11. Normalized Maximum Transient Thermal Impedance, Junction-to-Ambient



Inductive switching Test



Gate Charge Test

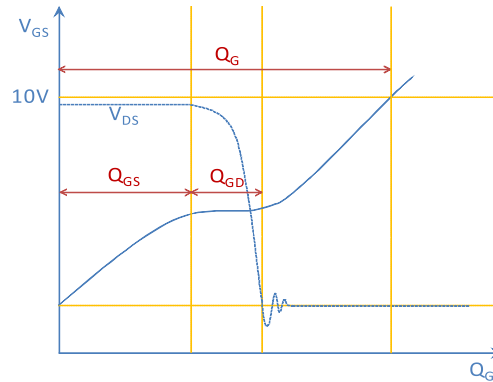
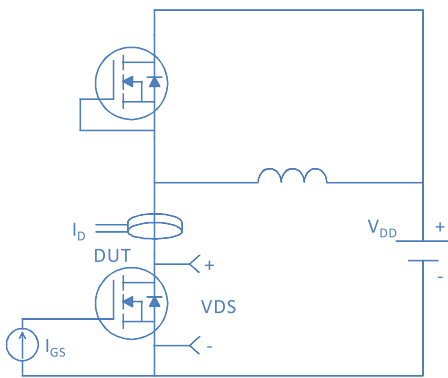

Uclamped Inductive Switching (UIS) Test

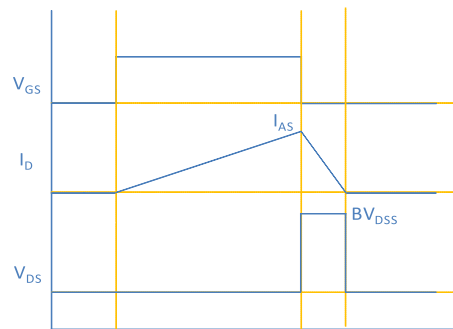
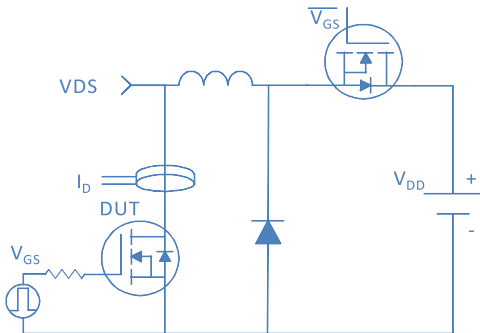

Diode Recovery Test

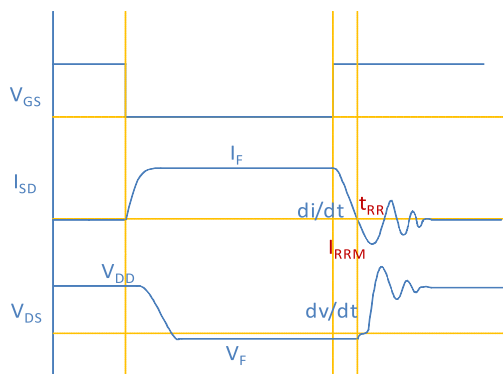
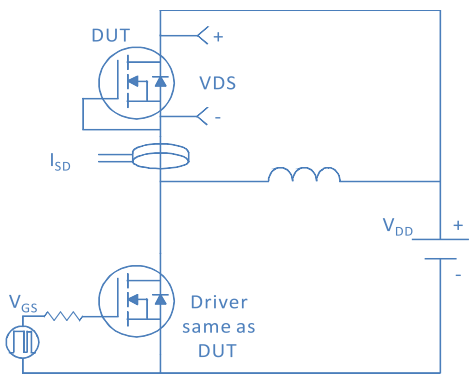

Package Outline

SOIC-8, 8 leads

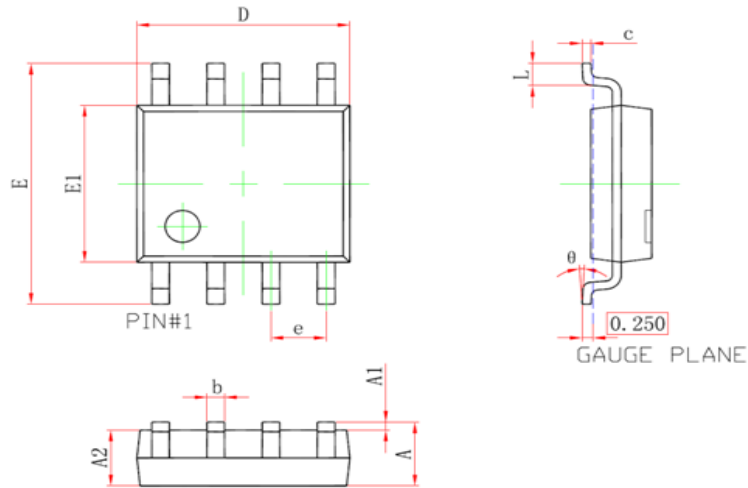

Symbol	Dimensions In Millimeters		Dimensions In Inches	
	Min	Max	Min	Max
A	1.350	1.750	0.053	0.069
A1	0.100	0.250	0.004	0.010
A2	1.250	1.650	0.049	0.065
b	0.310	0.510	0.012	0.020
c	0.170	0.250	0.007	0.010
D	4.800	5.000	0.189	0.197
e	1.270 (BSC)		0.050 (SBC)	
E	5.800	6.200	0.228	0.244
E1	3.800	4.000	0.150	0.157
L	0.400	1.270	0.016	0.031
theta	0°	8°	0°	8°